

SGLOCKS

Newsletter

FEBRUARY 2022
ISSUE 90

NEW

SP LOCK PINS
AFTERMARKET
GAINSBOROUGH
PINS

NEW

SRS+
NEW FEATURES
& UPDATES

NEW

LOCKTON
NEW CYLINDER
ADDITIONS



Lock Pins

Specialty Products
 & Manufacturing, LLC



With 30+ years of specialised manufacturing in the security industry, SP LOCK PINS produces high-quality Lock Pins and Lock Pin Kits for locksmiths and leading lock brand manufacturers.



NEW

TE2 GAINSBOROUGH Aftermarket Pins



PRODUCT SPECIFICATION

- Gainsborough Compatible pins (TE2)
- Type: Bottom Pin
- Material: #360 Alloy Brass (Full-Hard)
- Colour: Brass
- Packet of 144
- Made in USA

NEW

TE2 - GAINSBOROUGH AFTERMARKET PINS



Art ID	Colour	Packet (qty: 144)
GAINS-BP0	* Gold *	CFP
GAINS-BP1	* Gold *	CFP
GAINS-BP2	* Gold *	CFP
GAINS-BP3	* Gold *	CFP
GAINS-BP4	* Gold *	CFP
GAINS-BP5	* Gold *	CFP
GAINS-BP6	* Gold *	CFP
GAINS-BP7	* Gold *	CFP
GAINS-BP8	* Gold *	CFP

To see the full range of SP Lock Pins go to

sglocks.com.au

** All pricing ex. GST**

NEW

L3-30 LASER ENGRAVER

The L3-30 is the latest Fiber Laser Engraver from LDC. The L3 series Engravers are professional Engravers perfectly suited to Locksmiths or similar that require a compact high quality commercial Laser Engraver, for fast engraving on items like Restricted Keys, Dog Tags, Scar Plates, Cylinders, Padlocks and 1000's of other things.

PRODUCT DESCRIPTION

- Fast, Quiet & Accurate
- Advanced Laser technology
- Laser Marking & Cutting
- Minimizes installation space due to compact size (can be placed on table)
- Safety Cover automatically closes when engraving is commenced & opens when finished.
- Black / White engraving options
- Internal camera enhances design process
- Laser auto focusing automatically finds the focus point
- Vacuum is automatically turned on & off as needed (very quiet) vacuum intakes dust and fumes keeping the work area clean and safe
- NEW easy to use **Magic Art 7** Software (Included)
- The sight protection glass on the safety door protects users when looking at the engraving job

PRODUCT SPECIFICATION

- Max Material Height 100mm
- Internal chamber area 350mm(W) x 100mm(H) x 170mm(D)
- Max Material Weight: 20kg
- Air Cooling
- Laser Power: 30W
- Class 1 Laser
- Size (W X H X D): 404 x 556 x 590 mm
- Machine Weight: 46Kg

NEW

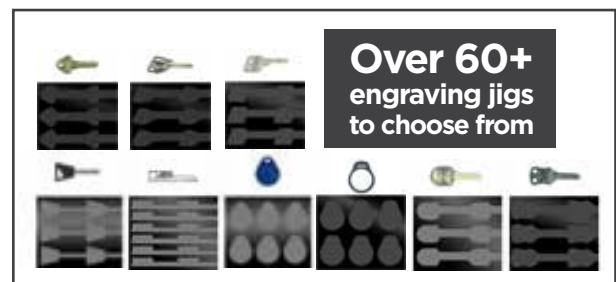
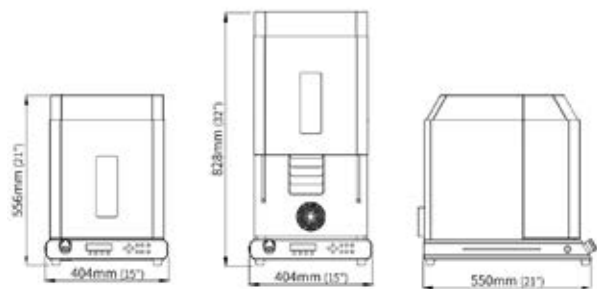

Check

sglocks.com.au

For Pricing!

Commercial Mortice Lock

**60mm
Backset**



SCAN to see the Full
LOCKTON Range on
SGLOCKS



**COMPLETE RANGE OF
LOCKS AND FURNITURE IN
STOCK**

Art. SG-ML60

Check

sglocks.com.au

For Pricing!

Suitable for use in
all heavy traffic areas
including:

- **Commercial**
- **Education**
- **Retail**
- **Industrial**
- **Medical**



4- Hour
Fire Rating



5 Year
Warranty



NEW

STANDARD MORTICE FACE PLATE - Suits Art.'s SG-ML60

PRODUCT DESCRIPTION:

The LT175-FPML60-SSS Standard Timber Face Plate to suit the LOCKTON Art. SG-ML60 Mortice Locks.

PRODUCT SPECIFICATION:

- Size: 175 mm x 25 mm
- Material: Satin Stainless Steel
- Suits Art. SG-ML60

Art. **LT175-FPML60-SSS**



NEW

ROUND END MORTICE FACE PLATE - Suits Art.'s SG-ML60

PRODUCT DESCRIPTION:

The LT175-REFPML60-SSS Round End Face Plate to suit the LOCKTON Art. SG-ML60 Mortice Locks.

PRODUCT SPECIFICATION:

- Size: 175 mm x 25 mm
- Material: Satin Stainless Steel
- Suits Art. SG-ML60

Art. **LT175-REFPML60-SSS**



NEW

TIMBER FACE PLATE - Suits Art.'s SG-SBML23 & SG-SBML30

PRODUCT DESCRIPTION:

The SG-LT260-FP-SSS Timber Face Plate to suit the LOCKTON Art. SG-SBML23 & SG-SBML30 Mortice Locks.

Used when wanting to install a Short Backset Mortice Lock on a Timber Door, Could also be used to cover some larger cut-outs when replacing a Euro Style Lock with the Art.SG-SBML23 or Art. SG-SBML30 Mortice Locks.

PRODUCT SPECIFICATION:

- Size: 260 mm x 25 mm
- Material: Satin Stainless Steel
- Suits Art. SG-SBML23 or Art. SG-SBML30



Art. **LT260-FP-SSS**



VISIT sglocks.com.au

TO VIEW THE ENTIRE LOCKTON RANGE



Art. 410-SC

LOCK CYLINDER (570) OVAL *Satin Chrome*

PRODUCT DESCRIPTION:

LOCKTON 410-SC, 570 Oval Cylinders are a commercial grade 6-pin solid brass cylinder, suitable for locks requiring an Australian Oval Cylinders.

PRODUCT SPECIFICATION :

- Made of Solid Brass
- Satin Chrome Finish
- C4 6-Pin with 2 x Keys (Keyed Versions)
- Available in KA (Keyed Alike), KD (Keyed to Differ) or ALB (Less Barrel, Top Loaded ready for a Restricted Barrel) & TURN (Turn Snib)
- Suitable for Restricted Inline Key Systems
- Comes with Z,X,W & "Rabbit ear" Cams (the 4 x most common used Cams in Australia)
- Custom Laser Etching available



Art. 410-CP

LOCK CYLINDER (570) OVAL *Chrome Plate*

PRODUCT DESCRIPTION:

LOCKTON 410-CP, 570 Oval Cylinders are a commercial grade 6-pin solid brass cylinder, suitable for locks requiring an Australian Oval Cylinders.

PRODUCT SPECIFICATION :

- Made of Solid Brass
- Chrome Plate Finish
- C4 6-Pin with 2 x Keys (Keyed Versions)
- Available in KA (Keyed Alike), KD (Keyed to Differ) or ALB (Less Barrel, Top Loaded ready for a Restricted Barrel)
- Suitable for Restricted Inline Key Systems
- Comes with Z,X,W & "Rabbit ear" Cams (the 4 x most common used Cams in Australia)
- Custom Laser Etching available



Art. 410-PB

LOCK CYLINDER (570) OVAL *Polished Brass*

PRODUCT DESCRIPTION:

LOCKTON 410-PB, 570 Oval Cylinders are a commercial grade 6-pin solid brass cylinder, suitable for locks requiring an Australian Oval Cylinders.

PRODUCT SPECIFICATION :

- Made of Solid Brass
- Polished Brass Finish
- C4 6-Pin with 2 x Keys (Keyed Versions)
- Available in KA (Keyed Alike), KD (Keyed to Differ)
- Suitable for Restricted Inline Key Systems
- Comes with Z,X,W & "Rabbit ear" Cams (the 4 x most common used Cams in Australia)
- Custom Laser Etching available



Art. 410-BLK

LOCK CYLINDER (570) OVAL *Matt Black*

PRODUCT DESCRIPTION:

LOCKTON 410-BLK, 570 Oval Cylinders are a commercial grade 6-pin solid brass cylinder, suitable for locks requiring an Australian Oval Cylinders.

PRODUCT SPECIFICATION :

- Made of Solid Brass
- Matt Black Finish
- C4 6-Pin with 2 x Keys (Keyed Versions)
- Available in KD (Keyed to Differ)
- Suitable for Restricted Inline Key Systems
- Comes with Z,X,W & "Rabbit ear" Cams (the 4 x most common used Cams in Australia)
- Custom Laser Etching available



Art. 420-SC

LOCK CYLINDER (201) ROUND *Satin Chrome*

PRODUCT DESCRIPTION:

LOCKTON 420-SC, 201 Round Cylinders are a commercial grade 6-Pin solid brass cylinder, suitable for locks requiring an Australian 201 Cylinder (like Lockwood 001)

PRODUCT SPECIFICATION :

- Solid Brass (Cyl Body & Rose)
- Satin Chrome Finish
- C4 6-Pin with 2 x Keys (Keyed Versions)
- Available in KA (Keyed Alike), KD (Keyed to Differ) or ALB (Less Barrel, Top Loaded ready for a Restricted Barrel)
- Suitable for Restricted Inline Key Systems
- Supplied with a Large Solid Brass Cylinder Rose
- Custom Laser Etching Available



Art. 420-CP

LOCK CYLINDER (201) ROUND *Chrome Plate*

PRODUCT DESCRIPTION:

LOCKTON 420-CP, 201 Round Cylinders are a commercial grade 6-Pin solid brass cylinder, suitable for locks requiring an Australian 201 Cylinder (like Lockwood 001)

PRODUCT SPECIFICATION :

- Solid Brass (Cyl Body & Rose)
- Chrome Plate Finish
- C4 6-Pin with 2 x Keys (Keyed Versions)
- Available in KD (Keyed to Differ) or ALB (Less Barrel, Top Loaded ready for a Restricted Barrel)
- Suitable for Restricted Inline Key Systems
- Supplied with a Large Solid Brass Cylinder Rose
- Custom Laser Etching Available



Art. 420-PB

LOCK CYLINDER (201) ROUND *Polished Brass*

PRODUCT DESCRIPTION:

LOCKTON 420-PB, 201 Round Cylinders are a commercial grade 6-Pin solid brass cylinder, suitable for locks requiring an Australian 201 Cylinder (like Lockwood 001)

PRODUCT SPECIFICATION :

- Solid Brass (Cyl Body & Rose)
- Polished Brass Finish
- C4 6-Pin with 2 x Keys (Keyed Versions)
- Available in KD (Keyed to Differ)
- Suitable for Restricted Inline Key Systems
- Supplied with a Large Solid Brass Cylinder Rose
- Custom Laser Etching Available



Art. 420-BLK

LOCK CYLINDER (201) ROUND *Matt Black*

PRODUCT DESCRIPTION:

LOCKTON 420-BLK, 201 Round Cylinders are a commercial grade 6-Pin solid brass cylinder, suitable for locks requiring an Australian 201 Cylinder (like Lockwood 001)

PRODUCT SPECIFICATION :

- Solid Brass (Cyl Body & Rose)
- Matt Black Finish
- C4 6-Pin with 2 x Keys (Keyed Versions)
- Suitable for Restricted Inline Key Systems
- Supplied with a Large Solid Brass Cylinder Rose
- Custom Laser Etching Available

- + MORE VEHICLES
- + MORE INFORMATION
- + MORE SPEED
- + MORE CONVENIENCE



NEW

2019-2013 DAS3 (TWIST PROX) - Uses same method as above however must choose the smart key option when generating the key file. This DAS3 Variation has a Chrome PUSH Button inserted into the EIS. This can be removed and used as a (FOBIK TWIST) Ignition. These Smart keys are currently being sourced by SG. At this time we do not recommend to do the TWIST PROX Variation until a stable key has been sourced. It may be possible to use a normal FOBIK TWIST Ignition key with these in an emergency.

ALL-KEYS-LOST On Bench Eeprom method



Please report any PCB Variation to SG Support for further assistance

NEW

ADD NOTES

ADD NOTES FEATURE HAS BEEN ADDED. YOU CAN NOW SAVE YOUR OWN NOTES ON INDIVIDUAL VEHICLES

1. Look for & select the Add Notes button at the bottom of the screen on any Vehicle.
2. Fill in the NOTES section with your note & press Save Notes
3. Your Notes will now display on this vehicle. To Edit or change , just Select Add Notes again to amend the NOTE

1. **Add Notes**



Home / My Account / My SID Notes / Add a New Order Template

Add a New Order Template

Notes ID: SID3649-NOTES

2. **NOTES** [This vehicle uses the 315 MHZ SGT key option]

Photo	SRS ID (SID)	Vehicle
	SID3649	MERCEDES-BENZ 5-Class (2006 - 2013) V221 - FOBIK TWIST - TWIST PROX

Save Notes

2010-2013 DAS3 (TWIST PROX) - Uses same method as above however must choose the smart key option when generating the key file. This DAS3 Variation has a Chrome PUSH Button inserted into the EIS. This can be removed and used as a (FOBIK TWIST) Ignition. These Smart keys are currently being sourced by SG. At this time we do not recommend to do the TWIST PROX Variation until a stable key has been sourced. It may be possible to use a normal FOBIK TWIST Ignition key with these in an emergency.

ALL-KEYS-LOST On Bench Eeprom method



Please report any PCB Variation to SG Support for further assistance

3. **NOTES:** [This vehicle uses the 315 MHZ SGT key option]

NEW

HUGE AUTEL UPDATE FOR ALL-KEYS-LOST & ADD KEY PROCEDURES USING AUTEL IM608



AUTEL



SRS ID: SID3653
MERCEDES-BENZ S-Class (2006 - 2013) W221 - FOBIK TWIST -

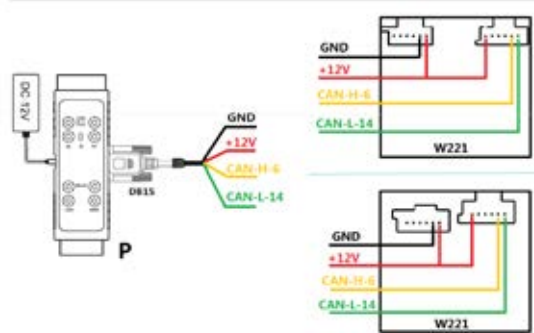

Added Complete Vehicle Database Including:

All-Keys-Lost & Add-Key Preferred methods +

Remote & Blade information, Lishi data, AUTEL wiring diagram pictures for GBOX 2 & Soldering point pictures for all models below.

- SID3576 MERCEDES-BENZ A-Class (2005 - 2010) W169 - FOBIK TWIST
- SID3577 MERCEDES-BENZ A-Class (2012 - 2018) W176 - FOBIK TWIST
- SID3582 MERCEDES-BENZ B-Class (2005 - 2011) W245 - FOBIK TWIST
- SID3583 MERCEDES-BENZ B-Class (2012 - 2018) W246 - FOBIK TWIST - FULL PROX
- SID3593 MERCEDES-BENZ C-Class (2000 - 2007) W203 - FOBIK TWIST
- SID3588 MERCEDES-BENZ C-Class (2001 - 2007) CL203 - FOBIK TWIST
- SID3590 MERCEDES-BENZ C-Class (2001 - 2007) S203 - FOBIK TWIST
- SID3594 MERCEDES-BENZ C-Class (2007 - 2014) W204 - FOBIK TWIST - PROX
- SID3586 MERCEDES-BENZ C-Class (2011 - 2015) C204 - FOBIK TWIST
- SID3600 MERCEDES-BENZ CL-Class (2000 - 2006) C215 - FOBIK TWIST
- SID3601 MERCEDES-BENZ CL-Class (2007 - 2014) C216 - FOBIK TWIST
- SID3596 MERCEDES-BENZ CLA-Class (2013 - 2019) C117 - FOBIK TWIST - FULL PROX
- SID3599 MERCEDES-BENZ CLC-Class (2008 - 2011) CL203 - FOBIK TWIST
- SID3604 MERCEDES-BENZ CLK-Class (2000 - 2002) C208 - FOBIK TWIST
- SID3602 MERCEDES-BENZ CLK-Class (2000 - 2003) A208 - FOBIK TWIST
- SID3605 MERCEDES-BENZ CLK-Class (2002 - 2009) C209 - FOBIK TWIST
- SID3603 MERCEDES-BENZ CLK-Class (2003 - 2009) A209 - FOBIK TWIST
- SID3607 MERCEDES-BENZ CLS-Class (2005 - 2011) C219 - FOBIK TWIST
- SID3606 MERCEDES-BENZ CLS-Class (2011 - 2017) C218 - FOBIK TWIST - FULL PROX
- SID3609 MERCEDES-BENZ CLS-Class (2012 - 2017) X218 - FOBIK TWIST - FULL PROX
- SID3617 MERCEDES-BENZ E-Class (2000 - 2002) W210 - FOBIK TWIST
- SID3618 MERCEDES-BENZ E-Class (2002 - 2009) W211 - FOBIK TWIST
- SID3614 MERCEDES-BENZ E-Class (2005 - 2009) S211 - FOBIK TWIST
- SID3612 MERCEDES-BENZ E-Class (2009 - 2016) C207 - FOBIK TWIST - PROX
- SID3619 MERCEDES-BENZ E-Class (2009 - 2016) W212 - FOBIK TWIST - PROX
- SID3610 MERCEDES-BENZ E-Class (2010 - 2016) A207 - FOBIK TWIST - PROX
- SID3615 MERCEDES-BENZ E-Class (2010 - 2016) S212 - FOBIK TWIST - PROX
- SID3624 MERCEDES-BENZ G-Class (2011 - 2021) W463 - FOBIK TWIST - PROX
- SID3630 MERCEDES-BENZ GL-Class (2006 - 2012) X164 - FOBIK TWIST
- SID3626 MERCEDES-BENZ GLA-Class (2013 - 2019) X156 - FOBIK TWIST - PROX
- SID3643 MERCEDES-BENZ M-Class (2005 - 2011) W164 - FOBIK TWIST - PROX
- SID3644 MERCEDES-BENZ M-Class (2012 - 2015) W166 - FOBIK TWIST - PROX
- SID3645 MERCEDES-BENZ R-Class (2006 - 2013) 251 - FOBIK TWIST
- SID3648 MERCEDES-BENZ S-Class (2000 - 2006) V220 - FOBIK TWIST
- SID3652 MERCEDES-BENZ S-Class (2000 - 2006) W220 - FOBIK TWIST
- SID3649 MERCEDES-BENZ S-Class (2006 - 2013) V221 - FOBIK TWIST - TWIST PROX
- SID3653 MERCEDES-BENZ S-Class (2006 - 2013) W221 - FOBIK TWIST - PROX
- SID3659 MERCEDES-BENZ SL-Class (2002 - 2012) R230 - FOBIK TWIST
- SID3662 MERCEDES-BENZ SLK-Class (2004 - 2011) R171 - FOBIK TWIST
- SID3663 MERCEDES-BENZ SLK-Class (2011 - 2016) R172 - FOBIK TWIST - PROX
- SID3664 MERCEDES-BENZ SLS-Class (2010 - 2014) C197 - FOBIK TWIST
- SID3665 MERCEDES-BENZ SLS-Class (2012 - 2014) R197 - FOBIK TWIST
- SID3667 MERCEDES-BENZ Sprinter (2006 - 2018) NCV3 (W906) - FOBIK TWIST
- SID3670 MERCEDES-BENZ Valente (2012 - 2015) 639 - FOBIK TWIST
- SID3672 MERCEDES-BENZ Viano (2005 - 2015) 639 - FOBIK TWIST
- SID3675 MERCEDES-BENZ Vito (2004 - 2015) 639 - FOBIK TWIST

"THE NEW SRS+
LOOKS AMAZING" - BRETT, SPL
SECURITY SOLUTIONS
QLD

"BEST THING
YOU GUYS'
HAVE EVER
DONE"

- BLAKE, BYRON BAY
LOCKSMITHS
NSW

"LOOKS VERY COOL"
- MATT, GUY NOR
LOCKSMITHS
WA

"THIS IS AWESOME
THANKS GUYS :)"
- CHANTELE, NIGHT &
DAY LOCKSMITHS
ACT



MORE OF WHAT YOU NEED

- + MORE VEHICLES
- + MORE INFORMATION
- + MORE SPEED
- + MORE CONVENIENCE

"THE WRITING'S ON THE WALL"

"THE NEW SRS'
IS A FANTASTIC
UPDATE" - LUKE,
LOCK LOGIC
NSW

"LOOKING NIFTY DUDE"
- HARVEY, ARHEFTON LOCKSMITHS
QLD

Art. EMOJIS

Pkt of 12 on Hang Card

NEW



PRODUCT DESCRIPTION

Cute keyrings to suit every user and personality

PRODUCT SPECIFICATIONS

- Pkt of 12 on Hang Card
- 9 assorted types per card



Art. KEYCAP

Pkt of 40 in Counter Display

NEW



PRODUCT DESCRIPTION

Identify and personalise your keys with these funny key caps, ideal for big or small key heads

PRODUCT SPECIFICATIONS

- Pkt of 40 on Counter Display
- 8 assorted types per box - 5 for Small & 3 for Big Key heads.



Art. KEYLOOP-12PKT

Pkt of 12 on Hang Card

NEW



PRODUCT DESCRIPTION

Comfortable and Practical Keyrings in Multiple colours to meet the taste of every user.

PRODUCT SPECIFICATIONS

- Pkt of 12 on Hang Card.
- 9 assorted colours per card.



Art. KEYLOOP-50PKT

Pkt of 50 in counter Display

NEW



PRODUCT DESCRIPTION

Comfortable and Practical Keyrings in Multiple colours to meet the taste of every user.

PRODUCT SPECIFICATIONS

- Pkt of 50 on Counter Display.
- 12 assorted colours per box.



SPEND OVER
\$750.00* ON

sglocks.com.au

In the one order
AND RECEIVE FREE

ANVIL HIDE COASTER SET



ANVIL HIDE

Leatherworks

Product Description

Sit your drinks down in style with a set of 4x SG Coasters made by Anvil Hide, handmade with care, using leather from Australia and the worlds best tanneries.

Every Anvil Hide product is handmade by one craftsman using the finest full grain leathers to create premium products that only get better with age.

3 Colours available - Medium Brown, Dark Brown & Black



" FEBRUARY 2022 Promo " valid until 28th FEBRUARY 2022 or whilst stocks last.
* Free Promotion item is only valid for online orders * Pricing shown excludes GST
All pricing within is accurate as of 01/02/2022 and is subject to change. For most accurate pricing please check the sglocks website.



Head Office
PH : 02 9352 0600
FAX: 02 9748 0566

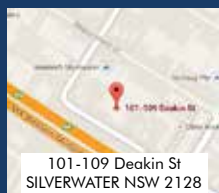

Your Sales Managers:

Colin McFarland
0491 445 005

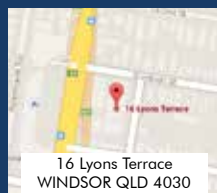

Vince Carson
0437 770 576

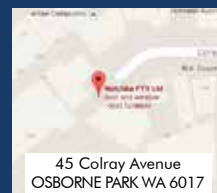

Jason Baker
0438 909 840

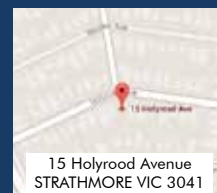

Henry Guldon
0400 613 714

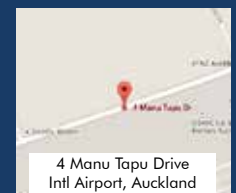

NZ Toll Free
0800 00 15 98